

LOŽISKOVÝ PLNOVÝSUV 2V1 PUSH A S TLMENÍM

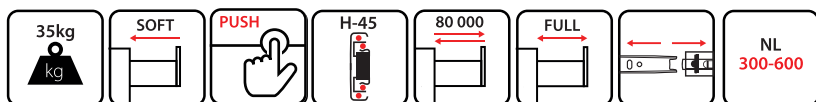

FUNKCIE

- ▶ Dostupné dĺžky
300,350,400,450,500,550,600
- ▶ Plnovýsuv
- ▶ 80 000 cyklov
- ▶ PUSH funkcia
- ▶ Tiché dovretie
- ▶ Max. zaťaženie: 35 kg
- ▶ Guličkové ložisko
- ▶ Skrutky do dreva sú súčasťou balenia
- ▶ Materiál: oceľ

MONTÁŽ VÝSUVOV

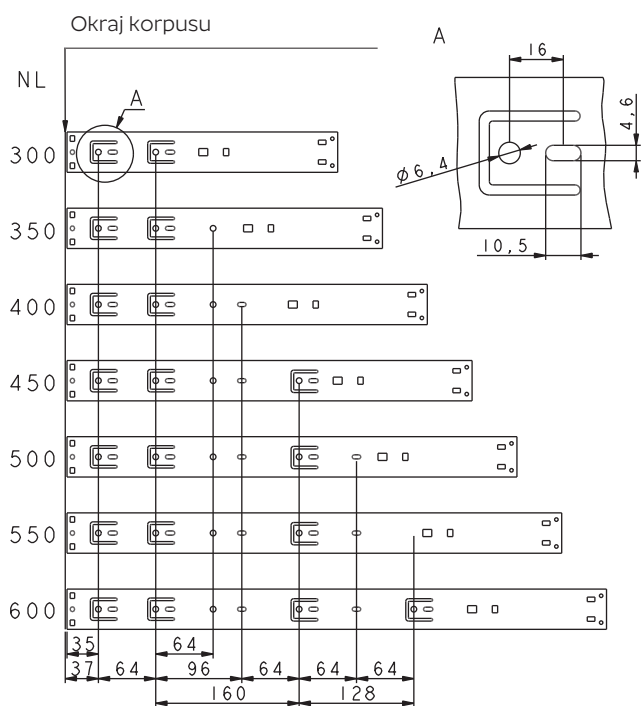

NL - Nominálna dĺžka

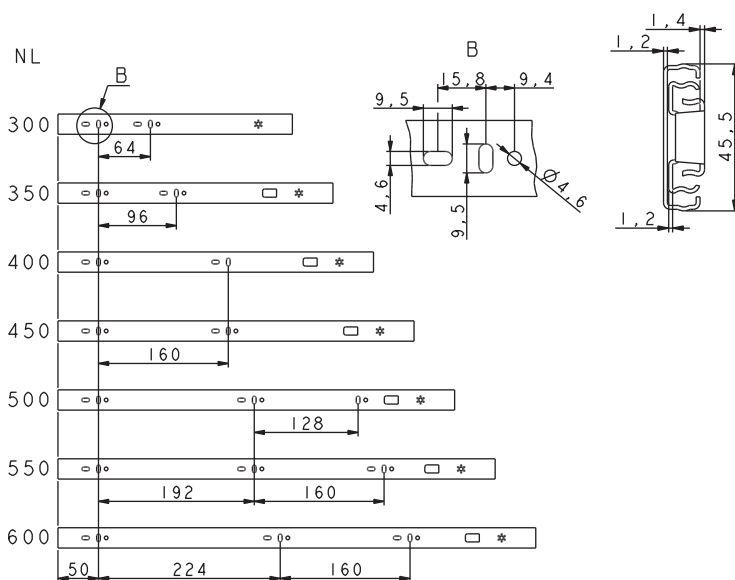

LOŽISKOVÝ PLNOVÝSUV 2V1 PUSH A S TLMENÍM

MONTÁŽ

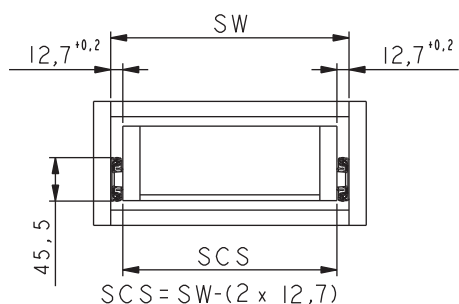

SW - VNÚTORNÁ ŠÍRKA KORPUSU
SCS - CELKOVÁ ŠÍRKA ZÁSUVKY

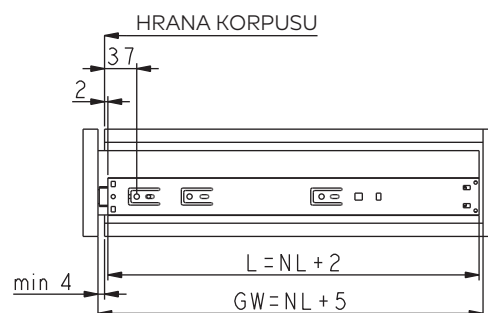

L - DĹŽKA VÝSUVU
GW - MIN. VNÚTORNÁ HĹBKA KORPUSU

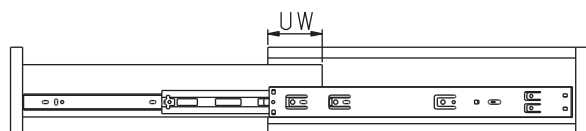

UW - STRATA DĹŽKY PRI VYSUNUTÍ VÝSUVU

NL	UW
300	50
350	35
400	-
450	-
500	-
550	-
600	-

AKO TO FUNGUJE?

1. STLAČENÍM OTVORTE

① PUSH



② OTVOR

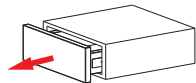

③ ZATVOR

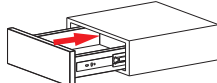

④ JEMNÉ ZATVORENIE

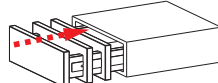

PUSH OR PULL

2. OTVORTE ŤAHOM

① POTIAHNI



② ZATVOR

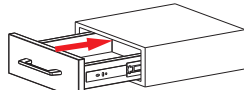

③ JEMNÉ ZATVORENIE

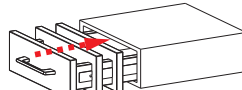

EN



BALENIE

