

Projektovanie

Rozmery závesu a výpočet medzery pri nastavení zo závodu (zvýšenie montážnej podložky = 0 mm)

Odskok dveriek pri uhle otvorenia 90°

Naložené dvere

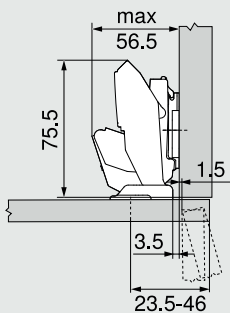
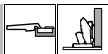

F Medzera

Polonaložené dvere

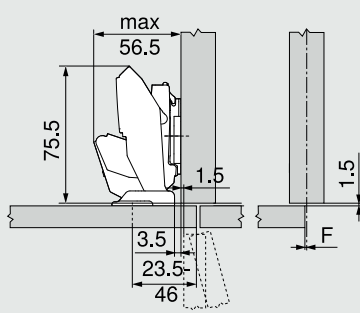
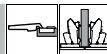

F Medzera

Vložené dvere

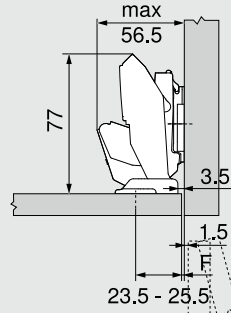
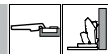

Polohu upevnenia montážnej podložky skrutkami posunúť naspäť o hrúbku čela FD + 1.5 mm
F Medzera

Miesto upevnenia

MD	Presah čela FA (mm)																		
	-3.5	-3	-2.5	-2	-1.5	-1	2.5	4	5.5	7	8.5	10	11.5	13	14.5	16	17.5	19	
0	23.5	24	24.5	25	25.5	26	29.5	31	32.5	34	35.5	37	38.5	40	41.5	43	44.5	46	
3	26.5	27	27.5	28	28.5	29	32.5	34	35.5	37	38.5	40	41.5	43	44.5	46			
6	29.5	30	30.5	31	31.5	32	35.5	37	38.5	40	41.5	43	44.5	46					
9	32.5	33	33.5	34	34.5	35	38.5	40	41.5	43	44.5	46							

MD Zvýšenie montážnych podložiek (mm)

Miesto upevnenia

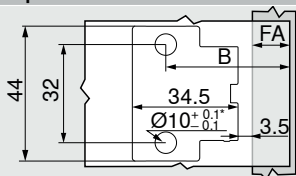

B Miesto upevnenia
 $B = FA + 27 \text{ mm} + MD$

FA Presah čela

MD Montážne podložky-zvýšenie

* Kameň a keramika +0.2/-0.1 mm

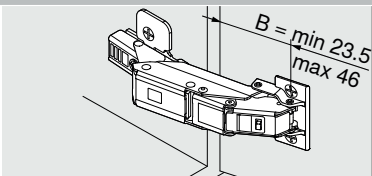

B Miesto upevnenia

Nastavenie



Max. ±3.0 mm
Pozri montážne podložky

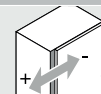

±2.0 mm

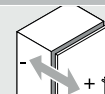

+3.0 mm
-2.0 mm

Hĺbka vrtania

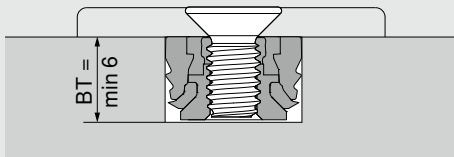

BT Hĺbka vrtania

Odstup montážnych podložiek MD – korpus na strane závesu je pri stene

SWD (mm)	Hrúbka čela FD (mm)						
	8	9	10	11	12	13	14
12							
13							
14							
15							
16							
17							
18							
19							
20							

SWD Hrúbka boku korpusu

Orange Zvýšenie montážnych podložiek MD 0 mm

Light Orange Zvýšenie montážnych podložiek MD 3 mm

Dark Orange Zvýšenie montážnych podložiek MD 6 mm